

# Tibidi®

## Features:

- Begins @\$275 armless / \$345 with arms
- High density stacker, stacks 45 high on a dolly, stacks 25 for upholstered versions
- Slim and minimalist design for multipurpose environments, cafés and private offices
- TD2 - color-matched polycolor on seat, back and arm caps
- TD2-S and TD2-F - seat and full upholstery available for added comfort

















# Tibidi (TD2-)

Stacking | Guest | Multi-use

- Tibidi Core Features:**
- HD Stacker
  - Stacks 45 High on Dolly
  - 275 lb. Weight Capacity
  - 7 Year Limited Warranty



**Note:** Green font color indicates default build for "most popular" configuration of this spread.

1. Model		2. Arms		3. Polycolor (Arms, Back and Seat match)		4. Frame Finish	
Code	List	Code	List	Code	List	Code	List
<b>TD2</b>	<b>\$275</b>	 <b>-N</b> (No arms)	<b>+\$0</b>	 <b>-BK01</b> Modern Black	<b>+\$0</b>	 <b>-CHM*</b> Chrome	<b>\$0</b>
		 <b>-A</b> (With arms)	<b>+\$70</b>	 <b>-GN04</b> Moss	<b>+\$0</b>	 <b>-BLK</b> Black	<b>+\$0</b>
				 <b>-BR01</b> Sand	<b>+\$0</b>	 <b>-WHT</b> White	<b>+\$0</b>
				 <b>-WT03</b> Snow White	<b>+\$0</b>	*Most durable option for frequent stacking / unstacking.	
				 <b>-BL04</b> Glacier	<b>+\$0</b>		
				 <b>-GR05</b> Fog	<b>+\$0</b>		
				 <b>-BL02</b> Navy	<b>+\$0</b>		
				 <b>-RD03</b> Brick	<b>+\$0</b>		

**Note:** Ganging Glides available and standard on armless version only.

**Note:** Bottom cover matches seat polycolor.

**OTHER OPTIONS** (append to above nomenclature to add to, or override existing options)

Polycolor	List	Glides	List	Dolly	List
<b>-A-polycolor #</b> Arm polycolor	<b>+\$5</b>	<b>-NGLD</b> Glideless option	<b>-\$5</b>	<b>-TD2DLY</b> Dolly	<b>+\$306</b>
<b>-B-polycolor #</b> Back polycolor	<b>+\$5</b>				
<b>-S-polycolor #</b> Seat polycolor	<b>+\$5</b>				

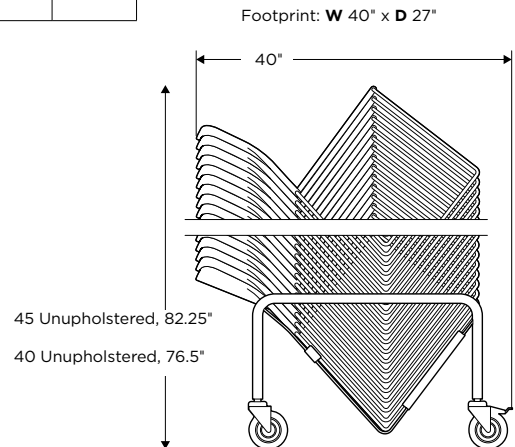





# Tibidi w/ Upholstered Seat (TD2-S)

Stacking | Guest | Multi-use



### Tibidi Core Features:

- HD Stacker with Upholstered Seat
- Stacks 25 High on Dolly
- 275 lb. Weight Capacity
- 7 Year Limited Warranty



**Note:** Green font color indicates default build for "most popular" configuration of this spread.

1. Model	
Code	List
TD2-S	\$275

2. Arms		
Code		List
 -N (No arms)		+\$0
 -A (With arms)		\$70

**Note:** Ganging Glides available and standard on armless version only.

3. Polycolor (Arms, Back and Seat match)		
Code		List
 -BK01 Modern Black		+\$0
 -GN04 Moss		+\$0
 -BR01 Sand		+\$0
 -WT03 Snow White		+\$0
 -BL04 Glacier		+\$0
 -GR05 Fog		+\$0
 -BL02 Navy		+\$0
 -RD03 Brick		+\$0

**Note:** Bottom cover matches seat polycolor.

4. Upholstery	
Currently Approved OM In-Stock Fabrics	
Code	List
• Grade 2 / SoftSit	+\$30
• Grade 3 / Wanderlust	+\$35
• Grade 3 / Cinema	+\$35
• Grade 3 / Illusion	+\$35

Fabric Application Testing is required for non-approved materials. Check with OM Seating for approved materials. [Click here](#) for Fabric Application Testing policy.

### OTHER OPTIONS (append to above nomenclature to add to, or override existing options)

Polycolor	List
-A-polycolor # Arm polycolor	+\$5
-B-polycolor # Back polycolor	+\$5

Glides	List
-NGLD Glideless option	-\$5

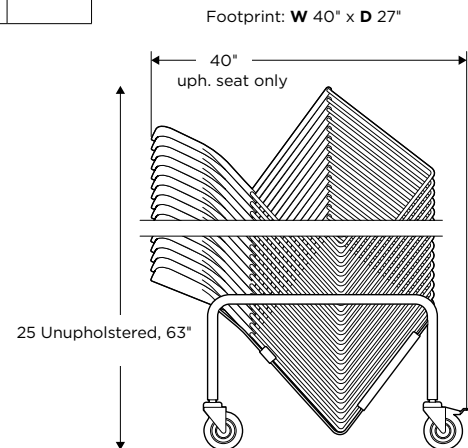

Dolly	List
-TD2DLY Dolly	+\$306



## MODEL CODE

Example: TD2-S -- N - BK01 - 3104 - CHM (new format)

Model #    Arm    Poly color    Seat uph.    Frame

4. Frame Finish		
	Code	List
	<b>-CHM*</b> Chrome	<b>\$0</b>
	<b>-BLK</b> Black	<b>+\$0</b>
	<b>-WHT</b> White	<b>+\$0</b>

\*Most durable option for frequent stacking / unstacking.

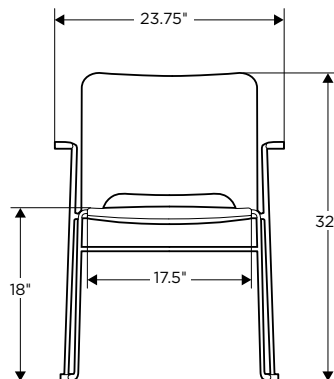
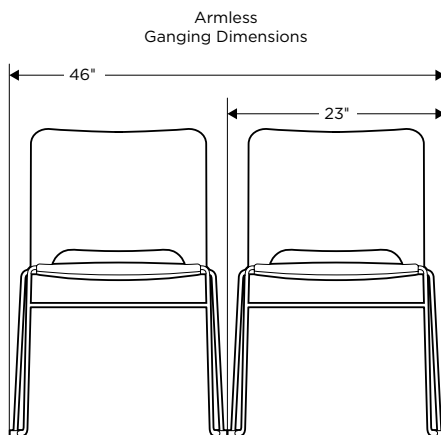

Dimensions	W	D	H
Overall	23.75"	23.75"	32"
Seat	17.5"	16.75"	18"
Back	17.5"	N/A	14"

Upholstery	Back	Seat	Backshell
COM	N/A	N/A	N/A
Shipping	Carton Wt.	FedEx Wt.	
	14 lbs.	121 lbs.	



# Tibidi Fully Upholstered (TD2-F)

Stacking | Guest | Multi-use

### Tibidi Core Features:

- HD Stacker Fully Upholstered
- Stacks 25 High on Dolly
- 275 lb. Weight Capacity
- 7 Year Limited Warranty



**Note:** Green font color indicates default build for "most popular" configuration of this spread.

1. Model		2. Arms		3. Upholstery		4. Frame Finish	
Code	List	Code	List	Code	List	Code	List
TD2-F	\$275	-N No arm	+\$0	• Grade 2 / SoftSit	+\$55	-CHM* Chrome	\$0
		-A (With arms)		• Grade 3 / Wanderlust	+\$65	-BLK Black	+\$0
		Choose a Polycolor for the arms		• Grade 3 / Cinema	+\$65	-WHT White	+\$0
		A-BK01 Modern Black	+\$70	Fabric Application Testing is required for non-approved materials. Check with OM Seating for approved materials. <a href="#">Click here</a> for Fabric Application Testing policy.		*Most durable option for frequent stacking / unstacking.	
		A-GN04 Moss	+\$0	<b>Note:</b> Bottom cover polycolor: • Black on CHM and BLK frames • White on WHT frames			
		A-BR01 Sand	+\$70				
		A-WT03 Snow White	+\$70				
		A-BL04 Glacier	+\$70				
		A-GR05 Fog	+\$70				
		A-BL02 Navy	+\$70				
		A-RD03 Brick	+\$70				

**Note:** Ganging Glides available and standard on armless version only.

### OTHER OPTIONS (append to above nomenclature to add to, or override existing options)

Glides	List	Mix and Match Seat and Back Upholstery	List	Dolly	List
-NGLD Glideless option	-\$5	-S Fabric Code Seat upholstery	+\$10	-TD2DLY Dolly	+\$306
		-B Fabric Code Back upholstery	+\$10		

