

# Plot Twist™

## Features:

- Upholstered Swivel Seat
- User in Seat: Weight Rating = 300 lbs.
- Objects on Tablet: Weight Rating = 100 lbs.
- 12-year Limited Warranty



Gold Seating Stools



Innovation Seating Stools



Innovation Collections for Collaborations



Business Innovation Award



Best in Show EDspaces Product Innovation



HiP Finalist



Healthcare Design



Chicago Athenaeum Museum of Art & Design





# Plot Twist™ Pouf (PLT-)

Collaborative seating

### Plot Twist Core Features:

- Upholstered Swivel Seat
- 300 lb. Weight Capacity
- 12-year Limited Warranty

**Note:** Green font color indicates default build for "most popular" configuration of this spread.

1. Model	
Code	List
<b>PLT-</b>	<b>\$899</b>

2. Seat Top Upholstery Option Fabric Application Testing Required	
Code	List
• <b>Grade 1 / C.O.M.</b>	<b>\$0</b>
• <b>Grade 2 / Grade-in A</b>	<b>+\$10</b>
• <b>Grade 3 / Grade-in B</b>	<b>+\$20</b>
• <b>Grade 4 / Grade-in C</b>	<b>+\$30</b>
• <b>Grade 5 / Grade-in D</b>	<b>+\$40</b>
• <b>Grade 6 / Grade-in E</b>	<b>+\$50</b>
• <b>Wersy Quilt</b>	<b>+\$45</b>
• <b>LG1 Evita / C.O.L.</b>	<b>+\$22</b>
• <b>LG2 Lena - LDEL, LLUT, LORC only*</b>	<b>+\$25</b>
• <b>LG3 Vulcano - LMIT, LSTG only*</b>	<b>+\$27</b>

Note: Fabric application testing is required for Grade-in and COM materials. Due to trilobe seat shape, patterns will not align. We recommend Solid and Solid Texture textiles.

\*For NON In-Stock colors, check with OM Seating for additional pricing details.

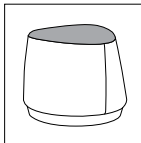

3. Side Panel Upholstery Option Fabric Application Testing Required	
Code	List
• <b>Grade 1 / C.O.M.</b>	<b>\$0</b>
• <b>Grade 2 / Grade-in A</b>	<b>+\$20</b>
• <b>Grade 3 / Grade-in B</b>	<b>+\$40</b>
• <b>Grade 4 / Grade-in C</b>	<b>+\$60</b>
• <b>Grade 5 / Grade-in D</b>	<b>+\$80</b>
• <b>Grade 6 / Grade-in E</b>	<b>+\$100</b>
• <b>LG1 Evita / C.O.L.</b>	<b>+\$67</b>
• <b>LG2 Lena - LDEL, LLUT, LORC only*</b>	<b>+\$75</b>
• <b>LG3 Vulcano - LMIT, LSTG only*</b>	<b>+\$82</b>

Note: Fabric application testing is required for Grade-in and COM materials. Due to trilobe seat shape, patterns will not align. We recommend Solid and Solid Texture textiles.

\*For NON In-Stock colors, check with OM Seating for additional pricing details.

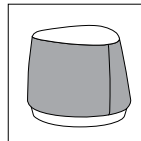

4. Retractable Rope Pull Handle Color	List
<b>-NR</b> No Rope	<b>+\$0</b>
<b>Standard Rope Colors</b>	
<b>-GR09</b> Stone Grey (matches GR01 Finish)	<b>+\$45</b>
<b>-GR10</b> Space Grey (matches GR04 Finish)	<b>+\$45</b>
<b>Premium Colors</b>	
<b>-BK03</b> Onyx Black	<b>+\$55</b>
<b>-GR11</b> Silver	<b>+\$55</b>
<b>-BR02</b> Khaki	<b>+\$55</b>
<b>-OR02</b> Bright Orange	<b>+\$55</b>
<b>-RD05</b> Bright Red	<b>+\$55</b>
<b>-RD06</b> Burnt Cherry	<b>+\$55</b>
<b>-VT01</b> Violet	<b>+\$55</b>
<b>-BL05</b> Ash Blue	<b>+\$55</b>
<b>-BL06</b> Regal Blue	<b>+\$55</b>
<b>-GN05</b> Hunter Green	<b>+\$55</b>
<b>-GN06</b> Kelly Green	<b>+\$55</b>

Note: Add "F-" for the Fixed rope version.

### OTHER OPTIONS (append to above nomenclature to add to, or override existing options)

Casters		
Code		List
 <b>-55C</b> 55mm Carpet Caster		<b>\$24</b>
 <b>-50SS</b> 50mm Safety Soft caster, minimizes chair movement when <b>NOT</b> in use		<b>\$30</b>
 <b>-50R</b> 50mm Reverse Brak- ing caster, restricts chair movement when chair <b>IS</b> in use		<b>\$42</b>

## ORDER NOMENCLATURE

Example: **PLT** — **3104** — **3104** — **NR** — **GR01** — **55MS**

Model #    Seat    Side    Rope    Base    Casters/  
              Uph    Uph    Handle    Finish    Glide

5. Base Finishes			6. Casters / Glide		
Code		List	Code		List
	<b>-GR01</b> Palladium Grey	<b>+\$0</b>		<b>-55MS</b> 55mm Multi-Surface Casters	<b>+\$0</b>
	<b>-GR04</b> Graphite	<b>+\$0</b>		<b>-GLD</b> Glide Base	<b>+\$52</b>

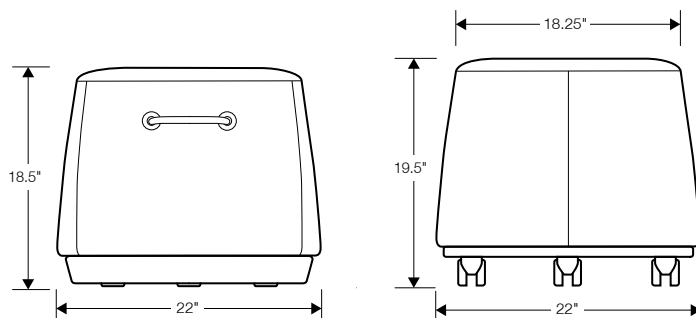

Dimensions	W	D	H
Overall (w/ glide base)	22"	22"	18.5"
Overall (w/ casters)	22"	22"	19.5"
Seat	18.25"	18.25"	18.25"
Back	N/A	N/A	N/A

Upholstery	Back	Pouf
COM*	N/A	1.5 yd.
Shipping	Carton Wt.	FedEx Wt.
	48 lbs.	101 lbs.

\*For big pattern repeats, check with OM



# Plot Twist™ with Tablet (PLT-T)

Collaborative seating

### Plot Twist Core Features:

- Upholstered Swivel Seat
- User in Seat: Weight Rating = 300 lbs.max
- Objects on Tablet: Weight Rating = 100 lbs. max
- 12-year Limited Warranty

**Note:** Green font color indicates default build for "most popular" configuration of this spread.

1. Model		2. Seat Top Upholstery Option Fabric Application Testing Required		3. Side Panel Upholstery Option Fabric Application Testing Required	
Code	List	Code	List	Code	List
<b>PLT-T</b> Plot Twist with Adjustable Height Tablet	<b>\$1,687</b>	• <b>Grade 1 / C.O.M.</b>	<b>\$0</b>	• <b>Grade 1 / C.O.M.</b>	<b>\$0</b>
<b>PLT-TF</b> Plot Twist with Fixed Height Tablet	<b>\$1,559</b>	• <b>Grade 2 / Grade-in A</b>	<b>+\$10</b>	• <b>Grade 2 / Grade-in A</b>	<b>+\$20</b>
		• <b>Grade 3 / Grade-in B</b>	<b>+\$20</b>	• <b>Grade 3 / Grade-in B</b>	<b>+\$40</b>
		• <b>Grade 4 / Grade-in C</b>	<b>+\$30</b>	• <b>Grade 4 / Grade-in C</b>	<b>+\$60</b>
		• <b>Grade 5 / Grade-in D</b>	<b>+\$40</b>	• <b>Grade 5 / Grade-in D</b>	<b>+\$80</b>
		• <b>Grade 6 / Grade-in E</b>	<b>+\$50</b>	• <b>Grade 6 / Grade-in E</b>	<b>+\$100</b>
		• <b>Weksy Quilt</b>	<b>+\$45</b>	• <b>LG1 Evita / C.O.L.</b>	<b>+\$67</b>
		• <b>LG1 Evita / C.O.L.</b>	<b>+\$22</b>	• <b>LG2 Lena - LDEL, LLUT, LORC only*</b>	<b>+\$75</b>
		• <b>LG2 Lena - LDEL, LLUT, LORC only*</b>	<b>+\$25</b>	• <b>LG3 Vulcano - LMIT, LSTG only*</b>	<b>+\$82</b>
		• <b>LG3 Vulcano - LMIT, LSTG only*</b>	<b>+\$27</b>		

Note: Fabric application testing is required for Grade-in and COM materials. Due to trilobe seat shape, patterns will not align. We recommend Solid and Solid Texture textiles.



Note: Fabric application testing is required for Grade-in and COM materials. Due to trilobe seat shape, patterns will not align. We recommend Solid and Solid Texture textiles.

\*For NON In-Stock colors, check with OM Seating for additional pricing details.

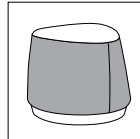
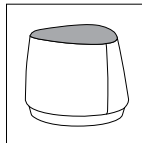
\*For NON In-Stock colors, check with OM Seating for additional pricing details.





### OTHER OPTIONS (append to above nomenclature to add to, or override existing options)

Casters		
Code		List
 <b>-55C</b> 55mm Carpet Caster		<b>\$28</b>
 <b>-50SS</b> 50mm Safety Soft caster, minimizes chair movement when <b>NOT</b> in use		<b>\$35</b>
 <b>-50R</b> 50mm Reverse Brak- ing caster, restricts chair movement when chair <b>IS</b> in use		<b>\$49</b>



## ORDER NOMENCLATURE



Example: **PLT-T** — **3104** — **3104** — **RND** — **J0030** — **GR01** — **55MS**

Model #    Seat Uph    Side Uph    Tablet Shape    Tablet Finish    Base Package    Casters/Glide

4. Tablet Shapes		
Code		List
	<b>-RND</b> Round 18" diameter	<b>-\$15</b>
	<b>-REC</b> Rectangle 22" x 14"	<b>+\$0</b>

Note: Tablet surface will not have a button for Fixed Height (-TF) version.

5. Tablet Finishes		
Code		List
	<b>-J0030</b> FENIX® Blanco Alaska with natural finish polished edge MDF*	<b>+\$0</b>
	<b>-J0724</b> FENIX® Grigio Bromo with natural finish polished edge MDF	<b>+\$0</b>
	<b>-BAMB</b> Solid Bamboo Wood	<b>+\$49</b>

6. Base Packages (includes height adjustable button, column and base)		
Code		List
	<b>-GR01</b> Palladium Grey	<b>+\$0</b>
	<b>-GR04</b> Graphite	<b>+\$0</b>

7. Casters / Glide	
Code	List
<b>55MS</b> 55mm Multi-Surface Casters	<b>+\$0</b>
<b>GLD</b> Glide Base	<b>+\$52</b>

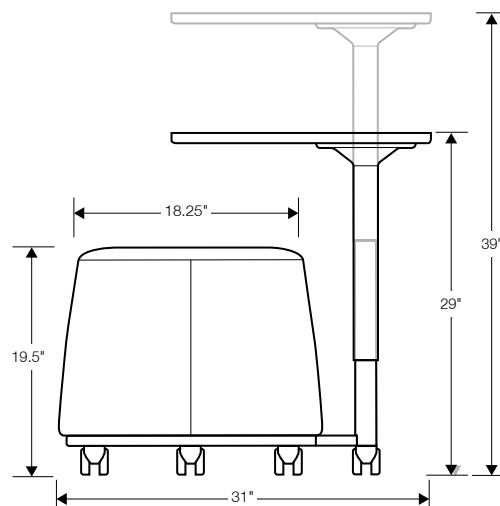

Dimensions	W	D	H
Overall	31"	22"	29" - 39"
Seat	18.25"	18.25"	N/A
Back	N/A	N/A	N/A

Upholstery	Back	Pouf
COM*	N/A	1.5 yd.
Shipping	Carton Wt.	FedEx Wt.
	67 lbs.	101 lbs.

\*For big pattern repeats, check with OM



# Plot Twist™ Pouf with Backrest (PLT-B)

Collaborative seating

### Plot Twist Core Features:

- Upholstered Swivel Seat
- 300 lb. Weight Capacity
- 12-year Limited Warranty

**Note:** Green font color indicates default build for "most popular" configuration of this spread.

1. Model		2. Back Upholstery Fabric Application Testing Required		2. Seat Top Upholstery Option Fabric Application Testing Required	
Code	List	Code	List	Code	List
<b>PLT-B</b> Plot Twist with Backrest	<b>\$1,040</b>	• <b>Grade 1 / C.O.M.</b>	<b>\$0</b>	• <b>Grade 1 / C.O.M.</b>	<b>\$0</b>
		• <b>Grade 2 / Grade-in A</b>	<b>+\$30</b>	• <b>Grade 2 / Grade-in A</b>	<b>+\$10</b>
		• <b>Grade 3 / Grade-in B</b>	<b>+\$50</b>	• <b>Grade 3 / Grade-in B</b>	<b>+\$20</b>
		• <b>Grade 4 / Grade-in C</b>	<b>+\$70</b>	• <b>Grade 4 / Grade-in C</b>	<b>+\$30</b>
		• <b>Grade 5 / Grade-in D</b>	<b>+\$90</b>	• <b>Grade 5 / Grade-in D</b>	<b>+\$40</b>
		• <b>Grade 6 / Grade-in E</b>	<b>+\$110</b>	• <b>Grade 6 / Grade-in E</b>	<b>+\$50</b>
		• <b>LG1 Evita / C.O.L.</b>	<b>+\$31</b>	• <b>Werksy Quilt</b>	<b>+\$45</b>
		• <b>LG2 Lena - LDEL, LLUT, LORC only**</b>	<b>+\$41</b>	• <b>LG1 Evita / C.O.L.</b>	<b>+\$22</b>
		• <b>LG3 Vulcano - LMIT, LSTG only**</b>	<b>+\$51</b>	• <b>LG2 Lena - LDEL, LLUT, LORC only*</b>	<b>+\$25</b>
				• <b>LG3 Vulcano - LMIT, LSTG only*</b>	<b>+\$27</b>

\* Grade 5 knit patterns will not have a back center vertical line stitch detail.

\*\* For NON In-Stock colors, check with OM Seating for additional pricing details.

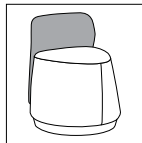

Note: Fabric application testing is required for Grade-in and COM materials. Due to trilobe seat shape, patterns will not align. We recommend Solid and Solid Texture textiles.

\*For NON In-Stock colors, check with OM Seating for additional pricing details.

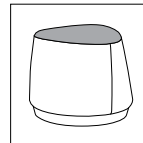

### OTHER OPTIONS (append to above nomenclature to add to, or override existing options)

Casters		
Code		List
 <b>-55C</b> 55mm Carpet Caster		<b>\$24</b>
 <b>-50SS</b> 50mm Safety Soft caster, minimizes chair movement when <b>NOT</b> in use		<b>\$30</b>
 <b>-50R</b> 50mm Reverse Brak- ing caster, restricts chair movement when chair <b>IS</b> in use		<b>\$42</b>

## ORDER NOMENCLATURE

Example: **PLT-B** — **3104** — **3104** — **3104** — **GR01** — **55MS**

Model #    Back Uph    Seat Uph    Side Uph    Base Finish    Casters/ Glide

3. Side Panel Upholstery Option Fabric Application Testing Required	
Code	List
• <b>Grade 1 / C.O.M.</b>	<b>\$0</b>
• <b>Grade 2 / Grade-in A</b>	<b>+\$20</b>
• <b>Grade 3 / Grade-in B</b>	<b>+\$40</b>
• <b>Grade 4 / Grade-in C</b>	<b>+\$60</b>
• <b>Grade 5 / Grade-in D</b>	<b>+\$80</b>
• <b>Grade 6 / Grade-in E</b>	<b>+\$100</b>
• <b>LG1 Evita / C.O.L.</b>	<b>+\$67</b>
• <b>LG2 Lena - LDEL, LLUT, LORC only*</b>	<b>+\$75</b>
• <b>LG3 Vulcano - LMIT, LSTG only*</b>	<b>+\$82</b>

Note: Fabric application testing is required for Grade-in and COM materials. Due to trilobe seat shape, patterns will not align. We recommend Solid and Solid Texture textiles.

\*For NON In-Stock colors, check with OM Seating for additional pricing details.

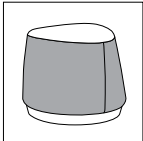

5. Base Finishes	
Code	List
<b>-GR01</b> Palladium Grey	<b>+\$0</b>
<b>-GR04</b> Graphite	<b>+\$0</b>

6. Casters / Glide	
Code	List
<b>55MS</b> 55mm Multi-Surface Casters	<b>\$0</b>
<b>GLD</b> Glide Base	<b>+\$52</b>

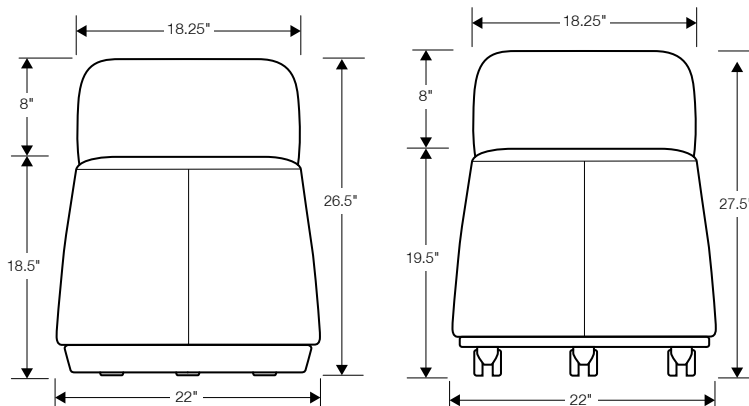

Dimensions	W	D	H
Overall (w/ glide base)	22"	24"	26.5"
Overall (w/ casters)	22"	24"	27.5"
Seat	18.25"	18.25"	18.5"
Back	N/A	N/A	8"

Upholstery	Back	Pouf
COM*	1.0 yd.	1.5 yd.
Shipping	Carton Wt.	FedEx Wt.
	53 lbs.	101 lbs.

\*For big pattern repeats, check with OM



# Plot Twist™ with Backrest & Tablet (PLT-BT)

Collaborative seating

## Plot Twist Core Features:

- Upholstered Swivel Seat
- User in Seat: Weight Rating = 300 lbs. max
- Objects on Tablet: Weight Rating = 100 lbs. max
- 12-year Limited Warranty

**Note:** Green font color indicates default build for "most popular" configuration of this spread.

1. Model		2. Back Upholstery		3. Seat Top Upholstery Option Fabric Application Testing Required		4. Side Panel Upholstery Option Fabric Application Testing Required	
Code	List	Code	List	Code	List	Code	List
<b>PLT-BT</b> Plot Twist with Backrest and Adjustable Height Tablet	<b>\$1,828</b>	• <b>Grade 1 / C.O.M.</b>	<b>\$0</b>	• <b>Grade 1 / C.O.M.</b>	<b>\$0</b>	• <b>Grade 1 / C.O.M.</b>	<b>\$0</b>
<b>PLT-BTF</b> Plot Twist with Backrest and Fixed Height Tablet	<b>\$1,700</b>	• <b>Grade 2 / Grade-in A</b>	<b>+\$30</b>	• <b>Grade 2 / Grade-in A</b>	<b>+\$10</b>	• <b>Grade 2 / Grade-in A</b>	<b>+\$20</b>
		• <b>Grade 3 / Grade-in B</b>	<b>+\$50</b>	• <b>Grade 3 / Grade-in B</b>	<b>+\$20</b>	• <b>Grade 3 / Grade-in B</b>	<b>+\$40</b>
		• <b>Grade 4 / Grade-in C</b>	<b>+\$70</b>	• <b>Grade 4 / Grade-in C</b>	<b>+\$30</b>	• <b>Grade 4 / Grade-in C</b>	<b>+\$60</b>
		• <b>Grade 5* / Grade-in D</b>	<b>+\$90</b>	• <b>Grade 5* / Grade-in D</b>	<b>+\$40</b>	• <b>Grade 5* / Grade-in D</b>	<b>+\$80</b>
		• <b>Grade 6 / Grade-in E</b>	<b>+\$110</b>	• <b>Grade 6 / Grade-in E</b>	<b>+\$50</b>	• <b>Grade 6 / Grade-in E</b>	<b>+\$100</b>
		• <b>LG1 Evita / C.O.L.</b>	<b>+\$31</b>	• <b>Werksy Quilt</b>	<b>+\$45</b>	• <b>LG1 Evita / C.O.L.</b>	<b>+\$67</b>
		• <b>LG2 Lena</b> - LDEL, LLUT, LORC only**	<b>+\$41</b>	• <b>LG1 Evita / C.O.L.</b>	<b>+\$22</b>	• <b>LG2 Lena</b> - LDEL, LLUT, LORC only*	<b>+\$75</b>
• <b>LG3 Vulcano</b> - LMIT, LSTG only**	<b>+\$51</b>	• <b>LG2 Lena</b> - LDEL, LLUT, LORC only*	<b>+\$25</b>	• <b>LG3 Vulcano</b> - LMIT, LSTG only*	<b>+\$82</b>		
		• <b>LG3 Vulcano</b> - LMIT, LSTG only*	<b>+\$27</b>				

\* Grade 5 knit patterns will not have a back center vertical line stitch detail.

\*\* For NON In-Stock colors, check with OM Seating for additional pricing details.

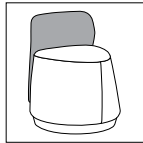

Note: Fabric application testing is required for Grade-in and COM materials. Due to trilobe seat shape, patterns will not align. We recommend Solid and Solid Texture textiles.

\*For NON In-Stock colors, check with OM Seating for additional pricing details.

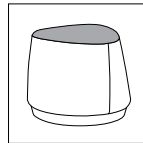

Note: Fabric application testing is required for Grade-in and COM materials. Due to trilobe seat shape, patterns will not align. We recommend Solid and Solid Texture textiles.

\*For NON In-Stock colors, check with OM Seating for additional pricing details.

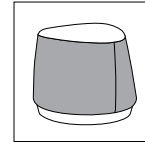

## OTHER OPTIONS (append to above nomenclature to add to, or override existing options)



Casters		
Code		List
 <b>-55C</b> 55mm Carpet Caster		<b>\$28</b>
 <b>-50SS</b> 50mm Safety Soft caster, minimizes chair movement when <b>NOT</b> in use		<b>\$35</b>
 <b>-50R</b> 50mm Reverse Brak- ing caster, restricts chair movement when chair <b>IS</b> in use		<b>\$49</b>





## ORDER NOMENCLATURE



Example: **PLT-BT** — **3104** — **3104** — **3104** — **REC** — **J0030** — **GR01** — **55MS**



Model #    Back Uph    Seat Uph    Side Uph    Tablet Shape    Tablet Finish    Base Package    Casters/ Glide

5. Tablet Shapes		
Code		List
	<b>-RND</b> Round 18" diameter	<b>-\$15</b>
	<b>-REC</b> Rectangle 22" x 14"	<b>+\$0</b>

Note: Tablet surface will not have a button for Fixed Height (-BTF) version.

6. Tablet Finishes		
Code		List
	<b>-J0030</b> FENIX® Blanco Alaska with natural finish polished edge MDF	<b>+\$0</b>
	<b>-J0724</b> FENIX® Grigio Bromo with natural finish polished edge MDF	<b>+\$0</b>
	<b>-BAMB</b> Solid Bamboo Wood	<b>+\$49</b>

7. Base Packages (includes height adjustable button, column and base)		
Code		List
	<b>-GR01</b> Palladium Grey	<b>+\$0</b>
	<b>-GR04</b> Graphite	<b>+\$0</b>

8. Casters / Glide		
Code		List
	<b>55MS</b> 55mm Multi-Surface Casters	<b>+\$0</b>
	<b>GLD</b> Glide Base	<b>+\$52</b>

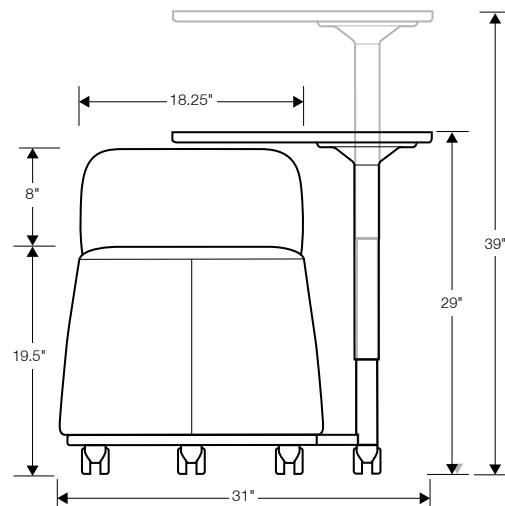

Dimensions	W	D	H
Overall	31"	24"	29" - 39"
Seat	18.25"	18.25"	N/A
Back	18.25"	N/A	8"

Upholstery	Back	Pouf
COM*	1.0	1.5 yd.
Shipping	Carton Wt.	FedEx Wt.
	74 lbs.	101 lbs.

\*For big pattern repeats, check with OM