

OM5 Active®

Features:

- Begins @ \$333 armless (OM5-AS) / \$376 with OM5 cantilever arms (OM5-AS-A . . .)
- OM5-AS - Sled-base mid-density stacking chair for any occasional use environment
- OM5-AG - 4-Leg stackable guest chair with options for casters or glides.
- OM5-AT - 5-Star base "tasker" for training rooms, computer labs, or simple task environments
- OM5-AC - Sled-base, stackable café stools with both bar and counter height seat options (30" & 24" seat heights, respectively)
- OM5-AN - Nesting, stacks 3, nests infinitely
- Designed by Francisco Romero of Phidesign





OM5 Active® Nest (OM5-AN)

Nesting | Guest | Multi-use

OM5 Active Nest Core Features:

- Unique Articulating Chair Top
- Stacks 3 and Nests Infinitely
- Built-in Ganging Clips
- 300 lb. Weight Capacity
- Lifetime Limited Warranty



Note: Green font color indicates default build for "most popular" configuration of this spread.

1. Model		2. Arms			3. Polyflex Shell Color Option		4. Back Upholstery	
Code	List	Code	List	Code	List	Code	List	
OM5-AN (Active Nest)	\$545	-N No arms	+\$0	-BK01 Modern Black	+\$0	PF Polyflex (Unupholstered)	+\$0	
OM5-FN (InActive Nest)	\$540	-A With Arms	+\$43	-GR01 Palladium Grey	+\$0	Grade 1 / C.O.M.	+\$48	
				-WT01 Arctic White	+\$0	Grade 2 / Grade-in A	+\$58	
				-GR04 Graphite	+\$0	Grade 3 / Grade-in B	+\$68	
				-BL02 Navy Blue	+\$0	Grade 4 / Grade-in C	+\$78	
				-RD02 Crimson Red	+\$0	Grade 5 / Grade-in D	+\$88	
				-GNO3 Seafoam Green	+\$0	Grade 6 / Grade-in E	+\$98	
				-YL01 Canary Yellow	+\$0	LG1 (Evita) / C.O.L.	+\$100	
						• LG2 Lena - LDEL, LLUT, LORC only*	+\$110	
						• LG3 Vulcano - LMIT, LSTG only*	+\$120	



Note: Bottom cover matches seat polycolor.

*For NON In-Stock colors, check with OM Seating for additional pricing details.

OTHER OPTIONS (append to above nomenclature to add to, or override existing options)

Glides & Casters		
Code		List
-BKSG	Modern Black Glides	+\$0
-GRSG	Palladium Grey Glides	+\$0
-SOR	Reverse Braking, restricted chair movement when chair IS in use	+\$25
-WBB	Wheelbarrow - Modern Black, Caster (front) and Glide (back) combo Note: matches BKCM Finish	+\$10
-WBG	Wheelbarrow - Palladium Grey, Caster (front) and Glide (back) combo Note: matches GRGM Finish	+\$10

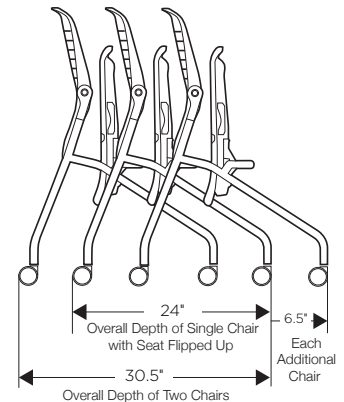



OM5 Active® Sled (OM5-AS)

Stacking | Guest | Multi-use

OM5 Active Sled Core Features:

- Unique Articulating Chair Top
- Built-in Ganging Clips
- 300 lb. Weight Capacity
- Lifetime Limited Warranty



Note: Green font color indicates default build for "most popular" configuration of this spread.

1. Model		2. Arms		3. Polyflex Shell Color Option	
Code	List	Code	List	Code	List
OM5-AS (Active Sled)	\$327	-N No arms	+\$0	-BK01 Modern Black	+\$0
OM5-FS (InActive Sled)	\$322	-A With arms	\$43	-GN01 Palladium Grey	+\$0
				-WT01 Arctic White	+\$0
				-GR04 Graphite	+\$0
				-BL02 Navy Blue	+\$0
				-RD02 Crimson Red	+\$0
				-GN03 Seafoam Green	+\$0
				-YL01 Canary Yellow	+\$0



Note: Bottom cover matches seat polycolor.

OTHER OPTIONS (append to above nomenclature to add to, or override existing options)

Miscellaneous Options		List
	-CFT Foam insert (provides additional comfort)	+\$66
	-BKTY Book Tray, black only	+\$58
	-FLTG Set of 4 felt glides	+\$10
	-STDLY5N Stacking Dolly	+\$397

Stacking with Dolly
20 unupholstered / 14 upholstered

Stacking Without Dolly
4 unupholstered / 4 upholstered

(can not stack with BKTY option. CFT option will decrease stackable quantity)

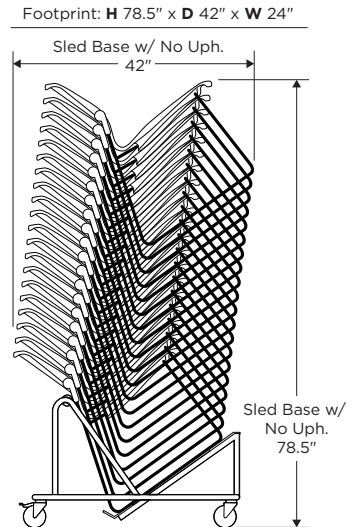

MODEL CODE

Example: **OM5-AS - N - BK01 - PF - PF - BKCM** (new format)

Model # Arm Poly color Back uph. Seat uph. Finish

4. Back Upholstery	
Code	List
PF Polyflex (Unupholstered)	+\$0
Grade 1 / C.O.M.	+\$48
Grade 2 / Grade-in A	+\$58
Grade 3 / Grade-in B	+\$68
Grade 4 / Grade-in C	+\$78
Grade 5 / Grade-in D	+\$88
Grade 6 / Grade-in E	+\$98
LG1 (Evita) / C.O.L.	+\$100
LG2 Lena - LDEL, LLUT, LORC only*	+\$110
LG3 Vulcano - LMIT, LSTG only*	+\$120

*For NON In-Stock colors, check with OM Seating for additional pricing details.

5. Seat Upholstery	
Code	List
PF Polyflex (Unupholstered)	+\$0
Grade 1 / C.O.M.	+\$48
Grade 2 / Grade-in A	+\$58
Grade 3 / Grade-in B	+\$68
Grade 4 / Grade-in C	+\$78
Grade 5 / Grade-in D	+\$88
Grade 6 / Grade-in E	+\$98
LG1 (Evita) / C.O.L.	+\$100
LG2 Lena - LDEL, LLUT, LORC only*	+\$110
LG3 Vulcano - LMIT, LSTG only*	+\$120

*For NON In-Stock colors, check with OM Seating for additional pricing details.

6. Finish Options (Frame, Armless and Arms Finish)	
Code	List
-BKCM (STD) Modern Black Color Match • Frame Finish: Modern Black • Armless/Arms Finish: Modern Black	\$0
-GRCM Palladium Grey Color Match • Frame Finish: Palladium Grey • Armless/Arms Finish: Palladium Grey	\$0
-CHBK • Frame Finish: Chrome • Armless/Arms Finish: Modern Black	\$0
-CHGR • Frame Finish: Chrome • Armless/Arms Finish: Palladium Grey	\$0
-GRBK • Frame Finish: Palladium Grey • Armless/Arms Finish: Modern Black	\$0

Armless

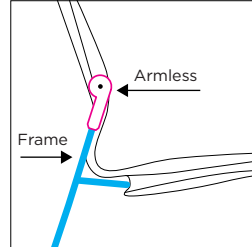

Arms

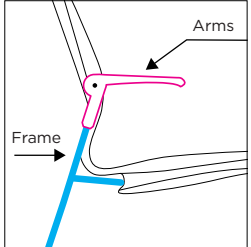



OM5 Active Ganging Clips
Built in ganging clips on both Sled (arm / armless)
and Guest (arm / armless)

Armless - Ganging Dimensions

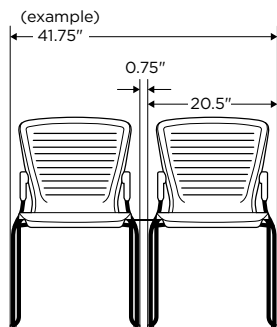

Arms - Ganging Dimensions

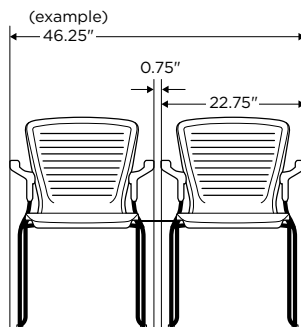

Dimensions	W	D	H
Overall	20.5" armless 22.75" w/ arms	24"	32.5"
Seat	18"	18"	18"
Back	17.5"	N/A	16"

Upholstery	Back	Seat	Backshell
COM	0.75 yds	0.75 yds	N/A
Shipping*	Carton Wt.	FedEx Wt.	
	25 lbs.	121 lbs.	

*Ships up to 2 per carton. A \$20 Net fee will apply for split cartoning (i.e., 2 Actives in 2 cartons)



OM5 Active® Café (OM5-AC)







Bar Height | Counter Height

OM5 Active Café Core Features:

- Counter or Bar Height Sled Base Café Stool
- Unique Articulating Chair Top
- 300 lb. Weight Capacity
- Lifetime Limited Warranty

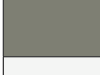
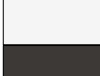

Note: Green font color indicates default build for "most popular" configuration of this spread.



1. Model		2. Arms			3. Polyflex Shell Color Option		4. Back Upholstery	
Code	List	Code		List	Code	List	Code	List
OM5-AC-24 (24" Active Café)	\$512	 -N No arms		+\$0	 -BK01 Modern Black	+\$0	PF Polyflex (Unupholstered)	+\$0
OM5-AC-30 (30" Active Café)	\$512	 -A With Arms		+\$43	 -GN01 Palladium Grey	+\$0	Grade 1 / C.O.M.	+\$48
OM5-FC-24 (24" InActive Café)	\$507				 -WT01 Arctic White	+\$0	Grade 2 / Grade-in A	+\$58
OM5-FC-30 (30" InActive Café)	\$507				 -GR04 Graphite	+\$0	Grade 3 / Grade-in B	+\$68
					 -BL02 Navy Blue	+\$0	Grade 4 / Grade-in C	+\$78
					 -RD02 Crimson Red	+\$0	Grade 5 / Grade-in D	+\$88
					 -GN03 Seafoam Green	+\$0	Grade 6 / Grade-in E	+\$98
					 -YL01 Canary Yellow	+\$0	LG1 (Evita) / C.O.L.	+\$100
							• LG2 Lena - LDEL, LLUT, LORC only*	+\$110
							• LG3 Vulcano - LMIT, LSTG only*	+\$120

Note: Bottom cover matches seat polycolor.

*For NON In-Stock colors, check with OM Seating for additional pricing details.



OTHER OPTIONS (append to above nomenclature to add to, or override existing options)

Miscellaneous Options		List
	-CFT (formerly -UPHCFT) Foam insert (provides additional comfort)	+\$66
	-BKTY Book Tray, Black only	+\$58

Stack 3 unupholstered or 3 upholstered without a Dolly

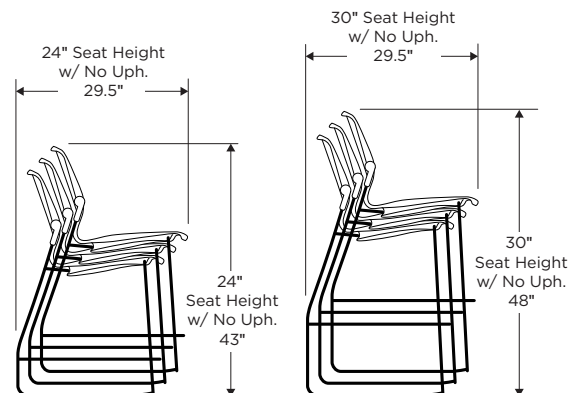

MODEL CODE

Example: OM5-AC-24 - N - BK01 - PF - PF - BKCM (new format)

Model # Arm Poly color Back uph. Seat uph. Finish

5. Seat Upholstery	
Code	List
PF Polyflex (Unupholstered)	+\$0
Grade 1 / C.O.M.	+\$48
Grade 2 / Grade-in A	+\$58
Grade 3 / Grade-in B	+\$68
Grade 4 / Grade-in C	+\$78
Grade 5 / Grade-in D	+\$88
Grade 6 / Grade-in E	+\$98
LG1 (Evita) / C.O.L.	+\$100
• LG2 Lena - LDEL, LLUT, LORC only*	+\$110
• LG3 Vulcano - LMIT, LSTG only*	+\$120

*For NON In-Stock colors, check with OM Seating for additional pricing details.

6. Finish Options (Frame, Armless and Arms Finish)	
Code	List
-BKCM <i>(STD) Modern Black Color Match</i> • Frame Finish: Modern Black • Armless/Arms Finish: Modern Black	+\$0
-CHBK • Frame Finish: Chrome • Armless/Arms Finish: Modern Black	+\$0
-CHGR • Frame Finish: Chrome • Armless/Arms Finish: Palladium Grey	+\$0

Armless

Arms

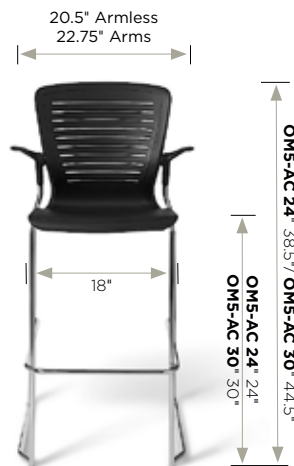

OM5-AC 24" and 30"

Dimensions	W	D	H
Overall	20.5" armless 22.75" w/ arms	25"	OM5-AC 24" 38.5" OM5-AC 30" 44.5"
Seat	18"	18"	OM5-AC 24" 24" OM5-AC 30" 30"
Back	17.5"	N/A	16"

Upholstery	Back	Seat	Backshell
COM	0.75 yds	0.75 yds	N/A
Shipping	Carton Wt.	FedEx Wt.	
	OM5-AC 24" 27 lbs. OM5-AC 30" 30 lbs.	165 lbs.	



OM5 Active® Guest (OM5-AG)

Stacking | Guest | Multi-use

OM5 Active 4-leg Guest Core Features:

- Unique Articulating Chair Top
- Built-in Ganging Clips
- 300 lb. Weight Capacity
- Lifetime Limited Warranty



Note: Green font color indicates default build for "most popular" configuration of this spread.

1. Model		2. Arms		3. Polyflex Shell Color Option		4. Back Upholstery	
Code	List	Code	List	Code	List	Code	List
OM5-AG (Active Guest)	\$355	-N No arms	+\$0	-BK01 Modern Black	+\$0	PF Polyflex (Unupholstered)	+\$0
OM5-FG (InActive Guest)	\$350	-A With arms	\$43	-GN01 Palladium Grey	+\$0	Grade 1 / C.O.M.	+\$48
		-TABR Right handed tablet arm*	\$125	-WT01 Arctic White	+\$0	Grade 2 / Grade-in A	+\$58
		-TABL Left handed tablet arm*	\$125	-GR04 Graphite	+\$0	Grade 3 / Grade-in B	+\$68
				-BL02 Navy Blue	+\$0	Grade 4 / Grade-in C	+\$78
				-RD02 Crimson Red	+\$0	Grade 5 / Grade-in D	+\$88
				-GN03 Seafoam Green	+\$0	Grade 6 / Grade-in E	+\$98
				-YL01 Canary Yellow	+\$0	LG1 (Evita) / C.O.L.	+\$100
						• LG2 Lena - LDEL, LLUT, LORC only*	+\$110
						• LG3 Vulcano - LMIT, LSTG only*	+\$120



*includes arm pads and available in black only.

Note: Bottom cover matches seat polycolor.

*For NON In-Stock colors, check with OM Seating for additional pricing details.

OTHER OPTIONS (append to above nomenclature to add to, or override existing options)

Miscellaneous Options		List
-CFT (formerly -UPHCFT) Foam insert (provides additional comfort)		+\$66
-BKTY Book Tray, black only		+\$58
-STDLY5N Stacking Dolly		+\$397

Stacking with Dolly
15 unupholstered / 9 upholstered

Stacking Without Dolly
4 unupholstered / 4 upholstered

(can not stack with TABR, TABL or BKTY option. CFT option will decrease quantity)

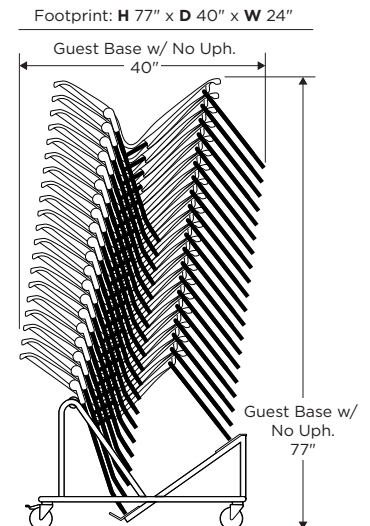

MODEL CODE

Example: **OM5-AG - N - BK01 - PF - PF - BKCM - BKSG** (new format)

Model # Arm Poly color Back uph. Seat uph. Finish Casters

5. Seat Upholstery	
Code	List
PF Polyflex (Unupholstered)	+\$0
Grade 1 / C.O.M.	+\$48
Grade 2 / Grade-in A	+\$58
Grade 3 / Grade-in B	+\$68
Grade 4 / Grade-in C	+\$78
Grade 5 / Grade-in D	+\$88
Grade 6 / Grade-in E	+\$98
LG1 (Evita) / C.O.L.	+\$100
• LG2 Lena - LDEL, LLUT, LORC only*	+\$110
• LG3 Vulcano - LMIT, LSTG only*	+\$120

*For NON In-Stock colors, check with OM Seating for additional pricing details.





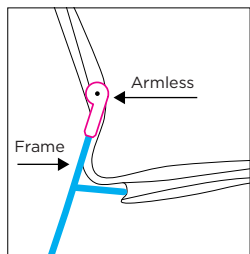

6. Finish Options (Frame, Armless and Arms Finish)	
Code	List
-BKCM (STD) Modern Black Color Match • Frame Finish: Modern Black • Armless/Arms Finish: Modern Black	+\$0
-GRCM Palladium Grey Color Match • Frame Finish: Palladium Grey • Armless/Arms Finish: Palladium Grey	+\$0
-GRBK • Frame Finish: Palladium Grey • Armless/Arms Finish: Modern Black	+\$0

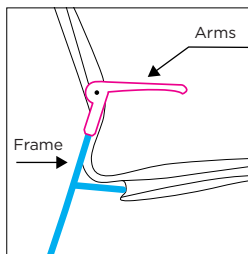
Armless



Arms



7. Caster Option	
Code	List
 -BKSG Modern Black glides (STD on BKCM)	+\$0
 -GRSG Palladium Grey glides (STD with GRCM and GRBK)	+\$0
 -50S (formerly AG) Active soft casters	+\$15
 -50SS (formerly -SS) Safety soft casters	+\$25
 -55MSB 55mm black two-tone multi-surface (55MSB) Note: matches BKCM Finish	+\$0
 -55MSG 55mm Grey two-tone multi-surface (55MSG) Note: matches GRCM Finish	+\$0
 -WBB Wheelbarrow - Modern Black, Caster (front) and Glide (back) combo Note: matches BKCM Finish	+\$10
 -WBG Wheelbarrow - Palladium Grey, Caster (front) and Glide (back) combo Note: matches GRCM Finish	+\$10

*Glide will match frame finish.



OM5 Active Ganging Clips
Built in ganging clips on both Sled (arm / armless) and Guest (arm / armless)

Armless - Ganging Dimensions

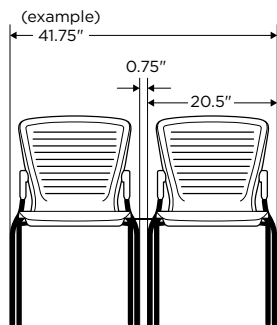

Arms - Ganging Dimensions

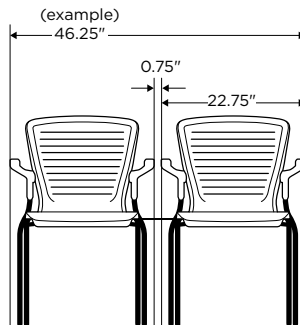

Dimensions	W	D	H
Overall	20.5" armless 22.75" w/ arms	24"	33"
Seat	18"	18"	18"
Back	17.5"	N/A	16"

Upholstery	Back	Seat	Backshell
COM	0.75 yds	0.75 yds	N/A
Shipping*	Carton Wt.	FedEx Wt.	
	28 lbs.	121 lbs.	

*Ships up to 2 per carton. A \$20 Net fee will apply for split cartoning (i.e., 2 Actives in 2 cartons)



OM5 Active® Multi-Tasker (OM5-AT)

Light Tasking | Multi-use

OM5 Active Tasker Core Features:

- 5-star Light Multi-Tasker
- Unique Articulating Chair Top
- 300 lb. Weight Capacity
- Lifetime Limited Warranty



Note: Green font color indicates default build for "most popular" configuration of this spread.

1. Model		2. Arms		3. Polyflex Shell Color Option		4. Back Upholstery	
Code	List	Code	List	Code	List	Code	List
OM5-AT (Active Tasker)	\$409	-N No arms	+\$0	-BK01 Modern Black	+\$0	PF Polyflex (Unupholstered)	+\$0
OM5-FT (InActive Tasker)	\$404	-A With arms	\$43	-GN01 Palladium Grey	+\$0	Grade 1 / C.O.M.	+\$48
				-WT01 Arctic White	+\$0	Grade 2 / Grade-in A	+\$58
				-GR04 Graphite	+\$0	Grade 3 / Grade-in B	+\$68
				-BL02 Navy Blue	+\$0	Grade 4 / Grade-in C	+\$78
				-RD02 Crimson Red	+\$0	Grade 5 / Grade-in D	+\$88
				-GN03 Seafoam Green	+\$0	Grade 6 / Grade-in E	+\$98
				-YL01 Canary Yellow	+\$0	LG1 (Evita) / C.O.L.	+\$100
						• LG2 Lena - LDEL, LLUT, LORC only*	+\$110
						• LG3 Vulcano - LMIT, LSTG only*	+\$120

Note: Bottom cover matches seat polycolor.

*For NON In-Stock colors, check with OM Seating for additional pricing details.

OTHER OPTIONS (append to above nomenclature to add to, or override existing options)

Miscellaneous Options		List	Caster Options		List	Caster Options		List
	-CFT (formerly -UPHCF) Foam insert (provides additional comfort)	+\$66		-50BC (formerly -TC) 50mm Carpet Casters (Standard on Base Package STDB)	\$0		-65MS (formerly -SC) 65mm Grey two-tone multi-surface soft caster	\$25
				-55MSB 55mm Black Two Tone Multi-Surface Soft Caster Standard on STDP Base Package Option on STDW Base Package	\$0		-50SS (formerly -SS) 50mm Safety Soft Casters (minimizes chair movement when NOT in use)	\$25
				-55MSW 55mm White Two-Tone Multi-Surface Soft Caster Standard on STDW Base Package Option on STDP Base Package	\$0		-50R (formerly -REV) 50mm Reverse Braking Caster (restricts chair movement when chair IS in use)	\$35
				-GLDR (formerly -G) Glides	\$0		-RUB Rubber Casters	\$25
				-50S (formerly -AG) 50mm Soft Casters	\$20			



MODEL CODE

Example: **OM5-AT - N - BK01 - PF - PF - STDB** (new format)

Model # Arm Poly color Back uph. Seat uph. Base pkg.

5. Seat Upholstery	
Code	List
PF Polyflex (Unupholstered)	+\$0
Grade 1 / C.O.M.	+\$48
Grade 2 / Grade-in A	+\$58
Grade 3 / Grade-in B	+\$68
Grade 4 / Grade-in C	+\$78
Grade 5 / Grade-in D	+\$88
Grade 6 / Grade-in E	+\$98
LG1 (Evita) / C.O.L.	+\$100
• LG2 Lena - LDEL, LLUT, LORC only*	+\$110
• LG3 Vulcano - LMIT, LSTG only*	+\$120

*For NON In-Stock colors, check with OM Seating for additional pricing details.

6. Task Base Packages (Includes Base, Cylinder and Casters)		
Code		List
	-STDB (formerly -B25) Standard Seat Height Package (Black) (Seat height: 16.5" - 21") <ul style="list-style-type: none"> • Cylinder: 5" Black (5AF) • Base: 25" Black nylon (25BAT) • Casters: 50mm Black carpet casters (50BC) 	\$0
	-STDP (formerly -WP25) Standard Seat Height Package (Polished) (Seat height: 16.5" - 21") <ul style="list-style-type: none"> • Cylinder: 5" Black (5BWY) • Base: 25" Two-tone polished aluminum (25PWY) • Casters: 55mm Black two-tone multi-surface (55MSB) 	\$68
	-STDW (formerly -WW25) Standard Seat Height Package (White) (Seat height: 16.5" - 21") <ul style="list-style-type: none"> • Cylinder: 5" White (5WWY) • Base: 25" White powdercoat (25WWY) • Casters: 55mm White two-tone multi-surface (55MSW) 	\$78



Dimensions	W	D	H
Overall	25"	25"	32" - 36.5"
Seat	18"	18"	16.5" - 21"
Back	17.5"	N/A	16"

Upholstery	Back	Seat	Backshell
COM	0.75 yds	0.75 yds	N/A
Shipping	Carton Wt.	FedEx Wt.	
	35 lbs.	65 lbs.	



OM5 Active® Multi-Tasker Stool (OM5-ATS)











Multi-use | Task Stool

OM5 Active Multi-Tasker Core Features:

- Multi-Tasker Stool with Turn-lock footring or Fixed Footring
- Unique Articulating Chair Top
- 300 lb. Weight Capacity
- Lifetime Limited Warranty









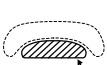

Note: Green font color indicates default build for "most popular" configuration of this spread.

1. Model		2. Arms			3. Polyflex Shell Color Option			4. Back Upholstery	
Code	List	Code		List	Code	List	Code	List	
OM5-ATS (Active Tasker Stool)	\$527		-N No arms	+\$0		-BK01 Modern Black	+\$0	PF Polyflex (Unupholstered)	+\$0
OM5-FTS (InActive Tasker Stool)	\$522		-A With arms	\$43		-GN01 Palladium Grey	+\$0	Grade 1 / C.O.M.	+\$48
						-WT01 Arctic White	+\$0	Grade 2 / Grade-in A	+\$58
						-GR04 Graphite	+\$0	Grade 3 / Grade-in B	+\$68
						-BL02 Navy Blue	+\$0	Grade 4 / Grade-in C	+\$78
						-RD02 Crimson Red	+\$0	Grade 5 / Grade-in D	+\$88
						-GN03 Seafoam Green	+\$0	Grade 6 / Grade-in E	+\$98
						-YL01 Canary Yellow	+\$0	LG1 (Evita) / C.O.L.	+\$100
								• LG2 Lena - LDEL, LLUT, LORC only*	+\$110
								• LG3 Vulcano - LMIT, LSTG only*	+\$120

Note: Bottom cover matches seat polycolor.

*For NON In-Stock colors, check with OM Seating for additional pricing details.

OTHER OPTIONS (append to above nomenclature to add to, or override existing options)

Miscellaneous Options		List	Caster Options		List	Substitute Cylinders		List
	-CFT (formerly -UPHCFT) Foam insert (provides additional comfort)	+\$66		-GLDR (formerly -G) Glides	+\$0		-OB8 8" Black Cylinder	+\$0
				-50S (formerly -AG) 50mm Soft Casters	\$20			
				-50SS (formerly -SS) 50mm Safety Soft Casters (minimizes chair movement when NOT in use.)	\$25		-OC8 8" Chrome Cylinder	+\$30
				-50R (formerly -REV) 50mm Reverse Braking Casters (restricts chair movement when chair IS in use.)	\$35			
				-RUB Rubber Casters	\$25			





MODEL CODE

Example: **OM5-ATS - N - BK01 - PF - PF - 8TLB** (new format)

Model # Arm Poly color Back uph. Seat uph. Base pkg.

5. Seat Upholstery	
Code	List
PF Polyflex (Unupholstered)	+\$0
Grade 1 / C.O.M.	+\$48
Grade 2 / Grade-in A	+\$58
Grade 3 / Grade-in B	+\$68
Grade 4 / Grade-in C	+\$78
Grade 5 / Grade-in D	+\$88
Grade 6 / Grade-in E	+\$98
LG1 (Evita) / C.O.L.	+\$100
• LG2 Lena - LDEL, LLUT, LORC only*	+\$110
• LG3 Vulcano - LMIT, LSTG only*	+\$120

*For NON In-Stock colors, check with OM Seating for additional pricing details.

6. Stool Base Packages (Includes Base, Cylinder and Casters)	
Code	List
Adjustable Footring	
 <p>-8TLB Standard Height Package with Adjustable Footring (Black) (Seat height: 21" - 29") <ul style="list-style-type: none"> • Cylinder: 8" Black (8BAT) • Footring: 20" Turn-lock footring • Base: 27" Black nylon (27BM) • Casters: 65mm Grey two-tone multi-surface soft caster (65MS) </p>	+\$0
 <p>-8TLP Standard Height Package with Adjustable Footring (Polished) (Seat height: 21" - 29") <ul style="list-style-type: none"> • Cylinder: 8" Chrome (8CHD) • Footring: 20" Turn-lock footring • Base: 27" Polished aluminum (27PM) • Casters: 65mm Grey two-tone multi-surface soft caster (65MS) </p>	+\$68
 <p>-10TLB High Seat Height Package with Adjustable Footring (Black) (Seat height: 25" - 35") <ul style="list-style-type: none"> • Cylinder: 10" Chrome (10CHD) • Footring: 20" Turn-lock footring • Base: 27" Black nylon (27BM) • Casters: 65mm Grey two-tone multi-surface soft caster (65MS) </p>	+\$30
 <p>-10TLP High Seat Height Package with Adjustable Footring (Polished) (Seat height: 25" - 35") <ul style="list-style-type: none"> • Cylinder: 10" Chrome (10CHD) • Footring: 20" Turn-lock footring • Base: 27" Polished aluminum (27PM) • Casters: 65mm Grey two-tone multi-surface soft caster (65MS) </p>	+\$98
Fixed Footring	
 <p>-8GSPC Standard Height Package with Fixed Footring (Chrome) (Seat height: 23.5" - 31.5") <ul style="list-style-type: none"> • Cylinder: 8" Chrome (8CHD) • Base: Chrome Grande Spider Base with fixed 22" footring (22GSPC) • Casters: 65mm Grey two-tone multi-surface (65MS) </p>	-\$30

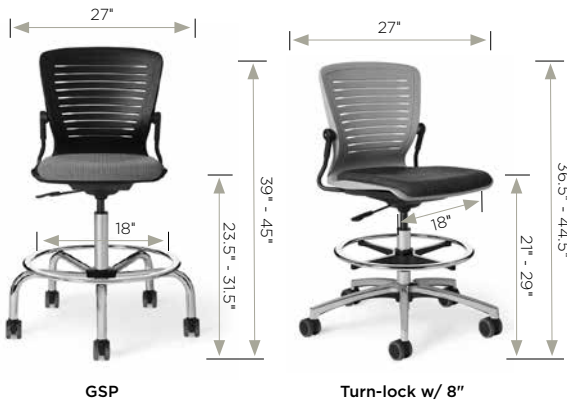

Dimensions are the same for Turn-lock with 8", Turn-lock w/10" and GSP except the overall height and seat height.

Dimensions (Turn-lock & GSP)	W	D	H (Turn-lock w/ 8")	H (Turn-lock w/ 10")	H (GSP)
Overall	27"	27"	36.5" - 44.5"	40.5" - 50.5"	39" - 47"
Seat	18"	18"	21" - 29"	25" - 36"	23.5" - 31.5"
Back	17.5"	N/A	16"		

Upholstery	Back	Seat	Backshell
COM	0.75 yds	0.75 yds	N/A
Shipping	Carton Wt.	FedEx Wt.	
	35 lbs.	65 lbs.	